

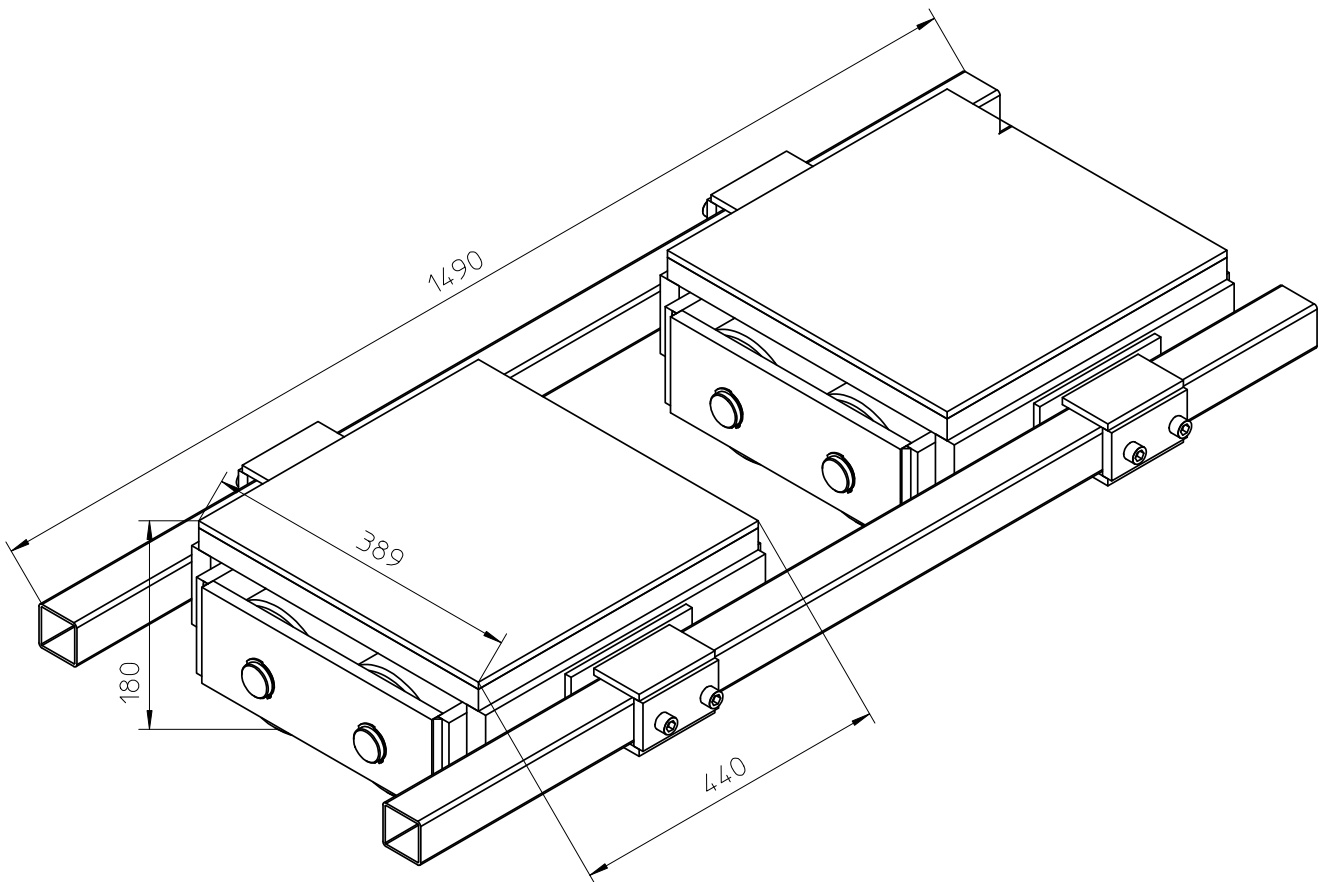

Typ F40



Otto Ballschmidt GmbH
Spezialunternehmen für Hebezeuge

Tel.: +49 341 909 8648-0

Fax.: +49 341 909 8648-1

Mail: info@ballschmidt-hebezeuge.de

Web: <http://www.ballschmidt-hebezeuge.de>